

Model Type: Standard with Integral Base
Description: 18" Standard with Integral Base (2-gang)

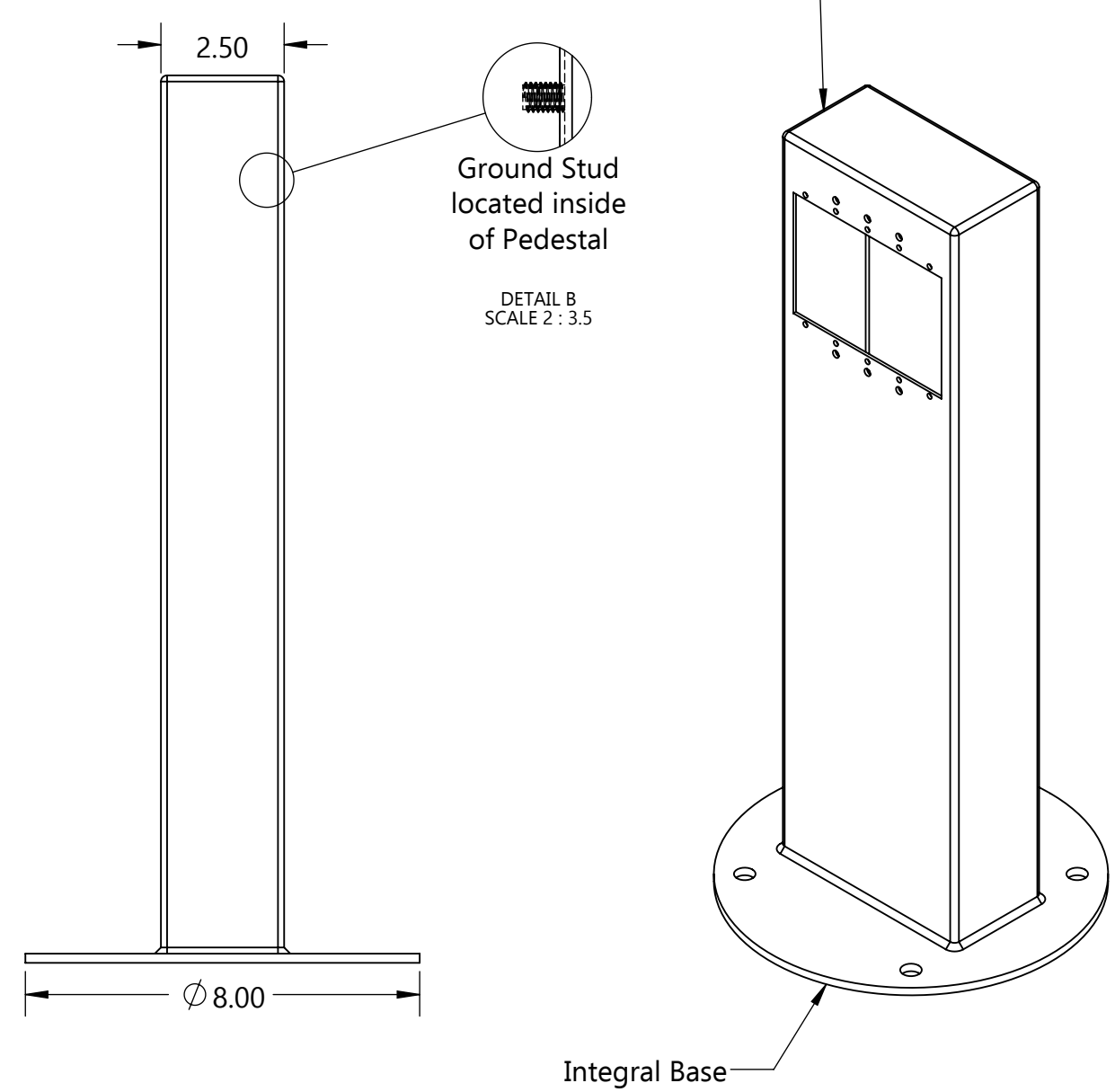

Part Numbers with Finish Indicated		Material	
Powder coated stainless steel			
Black (B)	2P18-C-B	Pedestal Body	14 gauge stainless steel
Gray (G)	2P18-C-G	Integral Base	7 gauge stainless steel
Bronze (BRZ)	2P18-C-BRZ		
Green (GN)	2P18-C-GN		
Brown (BR)	2P18-C-BR		
Custom (CSTM)	2P18-C-CSTM (paint chip req'd)	Packaged Dimensions	11" x 11" x 21"
Brushed stainless steel	2P18-SS	Packaged Weight	11 Lbs.

Base Mounting Hardware (included)
 (4) 1/4"-20 x 2-1/4" S.S. Wedge Anchors
 (4) 1/4"-20 S.S. High Crown Acorn Cap Nut
 (4) 1/4" x Ø 5/8" x .045" Thick S.S. Flat Washer

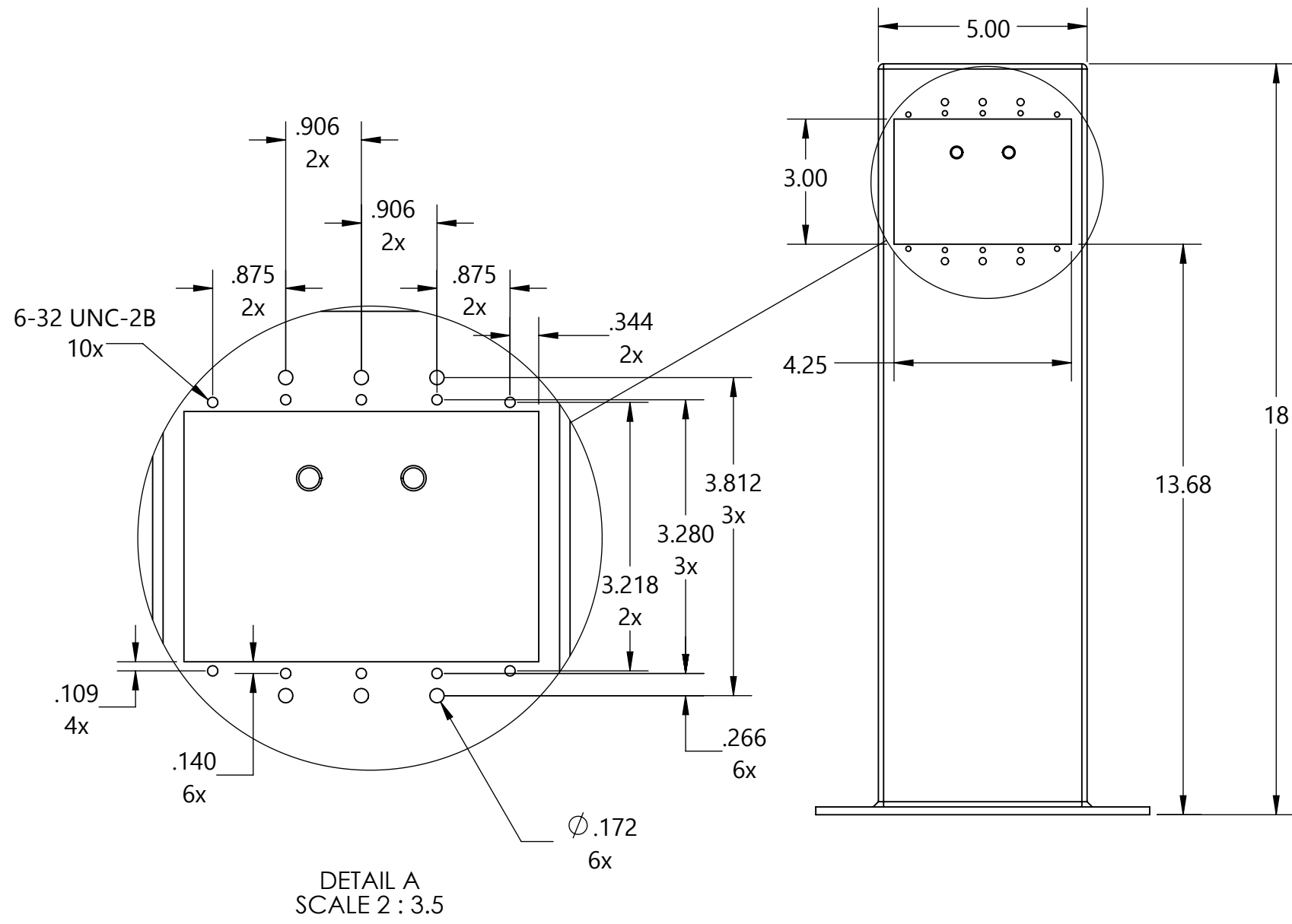