

Model Type: 5x5 Hinge Top Without Base: Direct Bury
Description: 42" 5x5 Hinge Top Without Base: Direct Bury

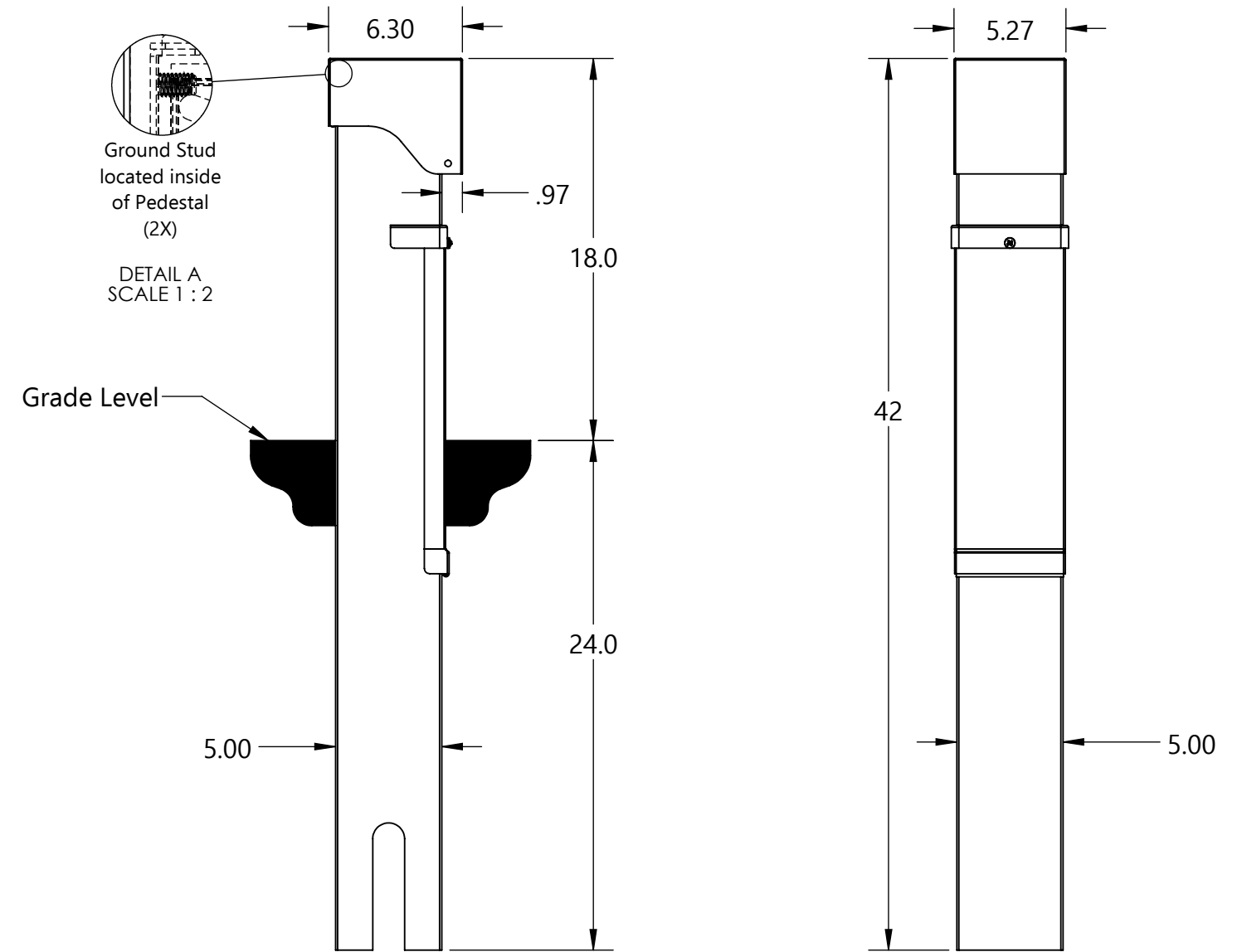
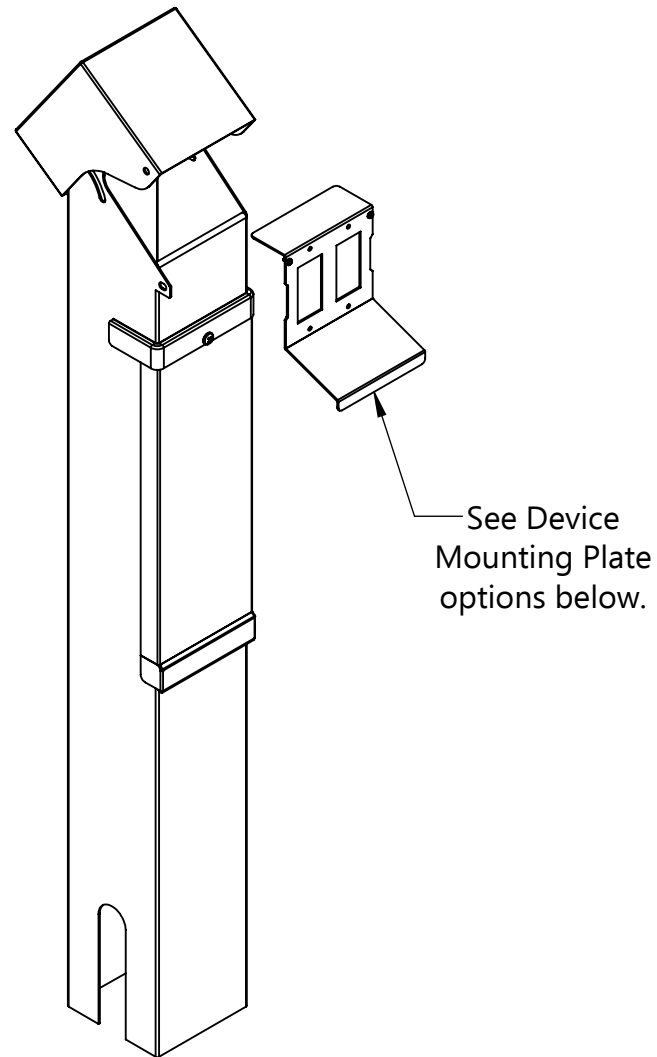
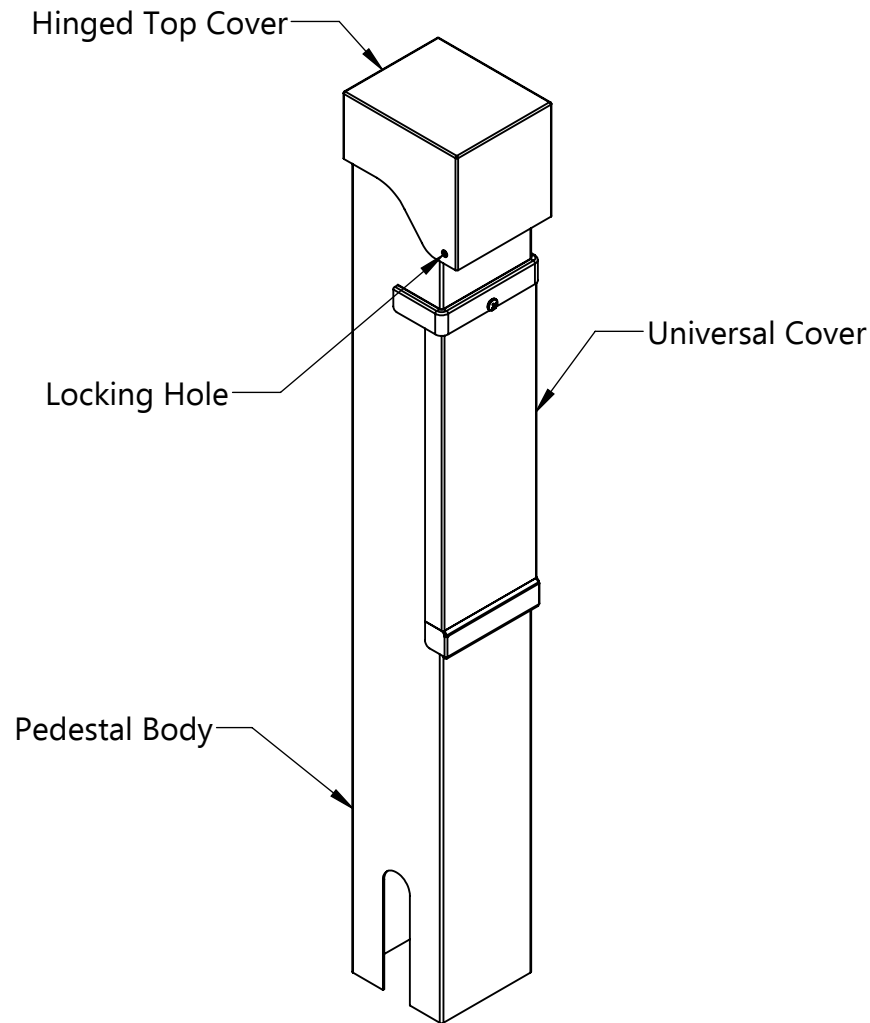

Material

14 Ga. 304 Stainless Steel: Pedestal Body, Top Cover, Universal Cover, Device Mounting Plate
 7 Ga. 304 Stainless Steel: Integral Base

Packaging

Boxed Dimensions: 11" x 11" x 45"
 Boxed Weight: 26 Lbs.

Part Numbering Reference

Finish/Configuration	Dual 15/20A GFCI	30A (1-9/16")	Dual 30A (1-9/16")	15/20A GFCI & 30A (1-9/16")	30/50A (2-1/8")	50/60A (Straight Blade Recommended)	30/50A (Turn Lock)
Powder Coated ("C")	542-C-HT-*-140	542-C-HT-*-142	542-C-HT-*-138	542-C-HT-*-144	542-C-HT-*-148	542-C-HT-*-154	542-C-HT-*-176
Brushed Finish ("SS")	542-SS-HT-140	542-SS-HT-142	542-SS-HT-138	542-SS-HT-144	542-SS-HT-148	542-SS-HT-154	542-SS-HT-176

* Color Code: B = Black, G = Gray, GN = Green, BR = Brown, BRZ = Bronze, CSTM = Custom Color

