

Model Type: 5x5 Hinge Top Without Base: Direct Bury
Description: 48" 5x5 Hinge Top Without Base: Direct Bury

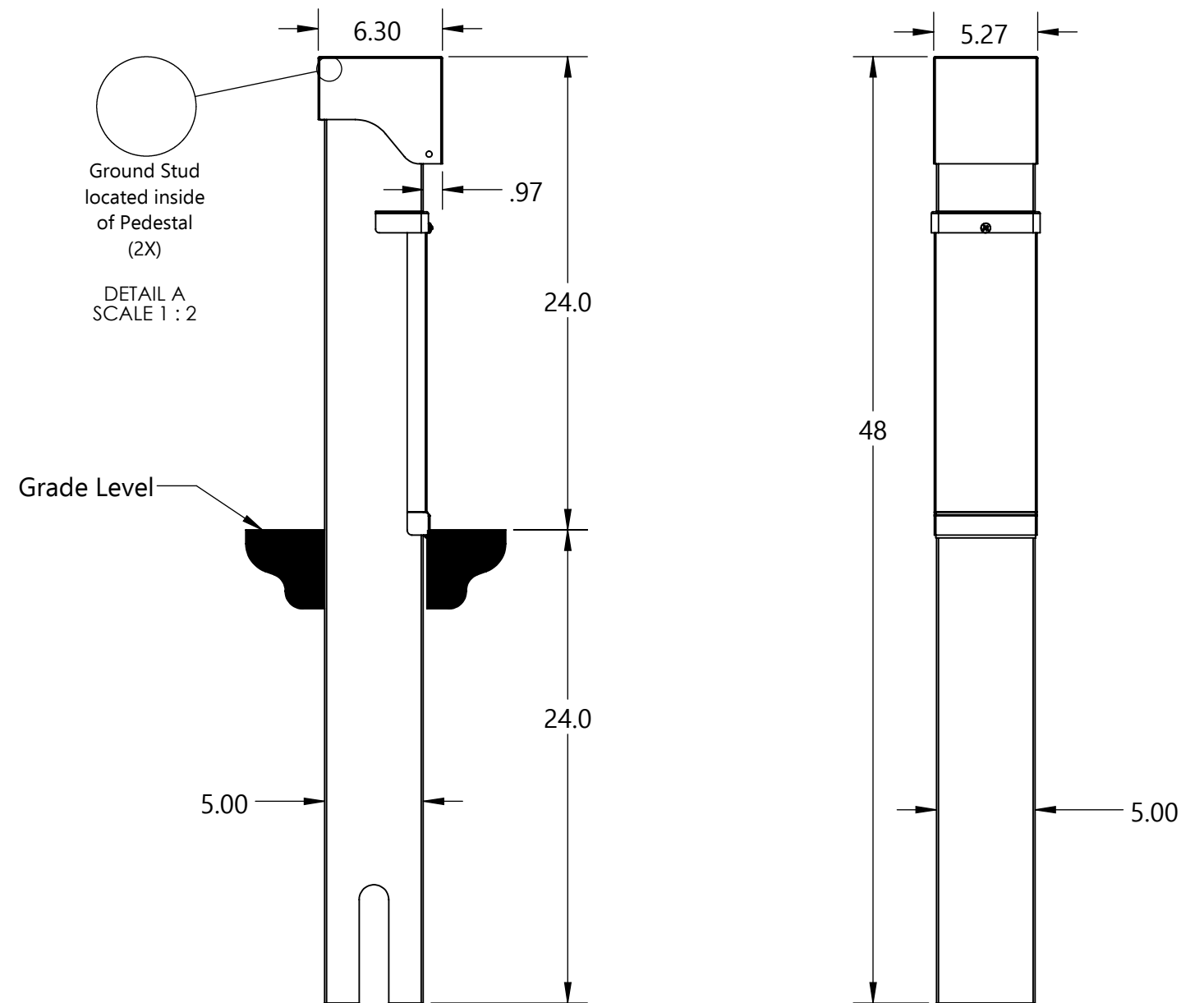
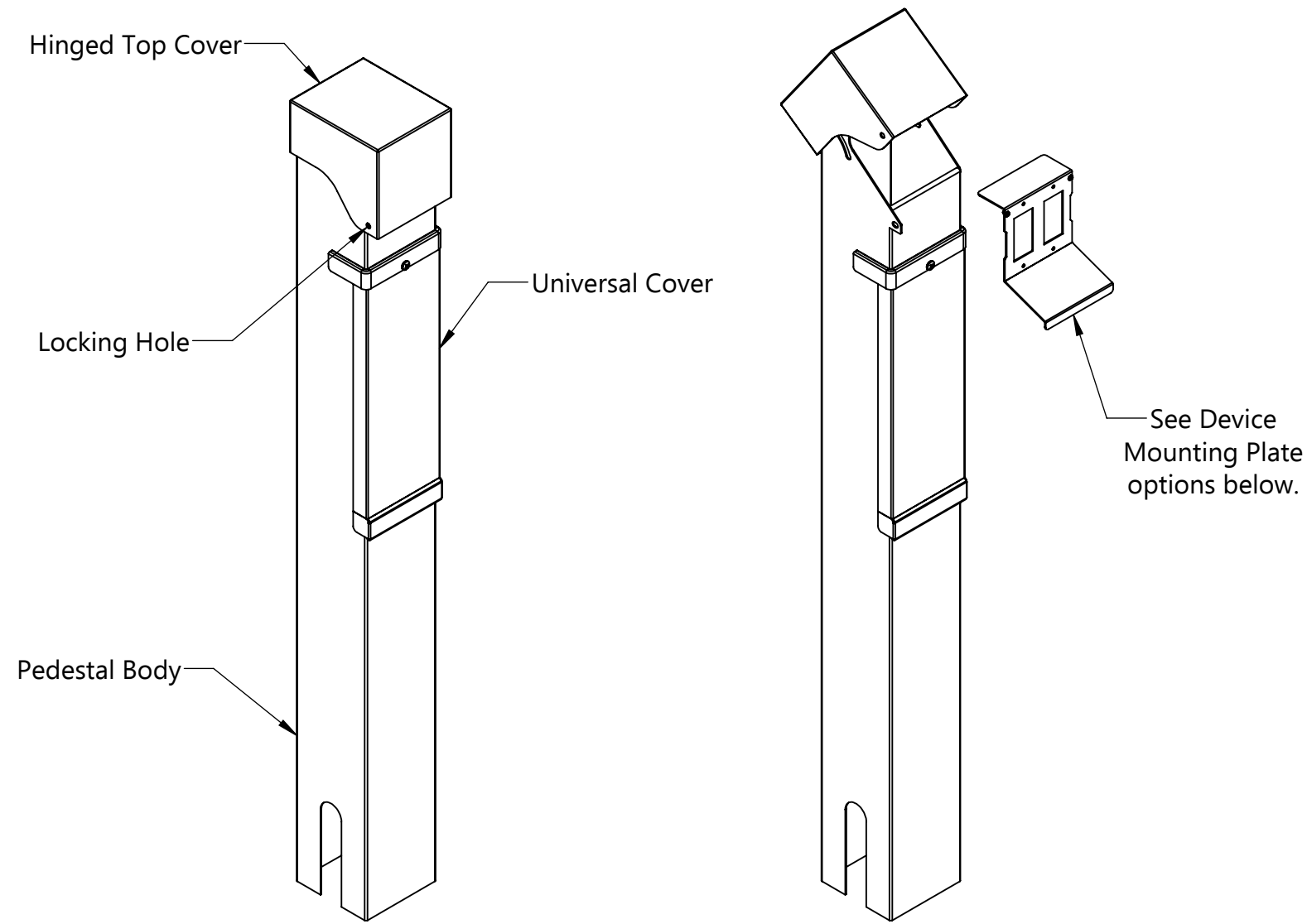

Material

14 Ga. 304 Stainless Steel: Pedestal Body, Top Cover, Universal Cover, Device Mounting Plate
 7 Ga. 304 Stainless Steel: Integral Base

Packaging

Boxed Dimensions: 11" x 11" x 52"
 Boxed Weight: 28 Lbs.

Part Numbering Reference

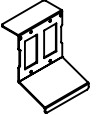
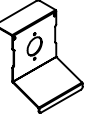
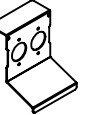
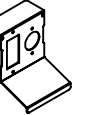
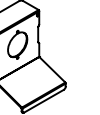
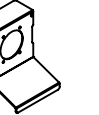
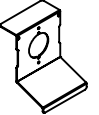
Finish/Configuration	Dual 15/20A GFCI	30A (1-9/16")	Dual 30A (1-9/16")	15/20A GFCI & 30A (1-9/16")	30/50A (2-1/8")	50/60A (Straight Blade Recommended)	30/50A (Turn Lock)
							
Powder Coated ("C")	548-C-HT-*-140	548-C-HT-*-142	548-C-HT-*-138	548-C-HT-*-144	548-C-HT-*-148	548-C-HT-*-154	548-C-HT-*-176
Brushed Finish ("SS")	548-SS-HT-140	548-SS-HT-142	548-SS-HT-138	548-SS-HT-144	548-SS-HT-148	548-SS-HT-154	548-SS-HT-176

* Color Code: B = Black, G = Gray, GN = Green, BR = Brown, BRZ = Bronze, CSTM = Custom Color

