

Model Type: Divided - 5x5 Hinge Top with Integral Base
Description: 30" Divided 5x5 Hinge Top with Integral Base

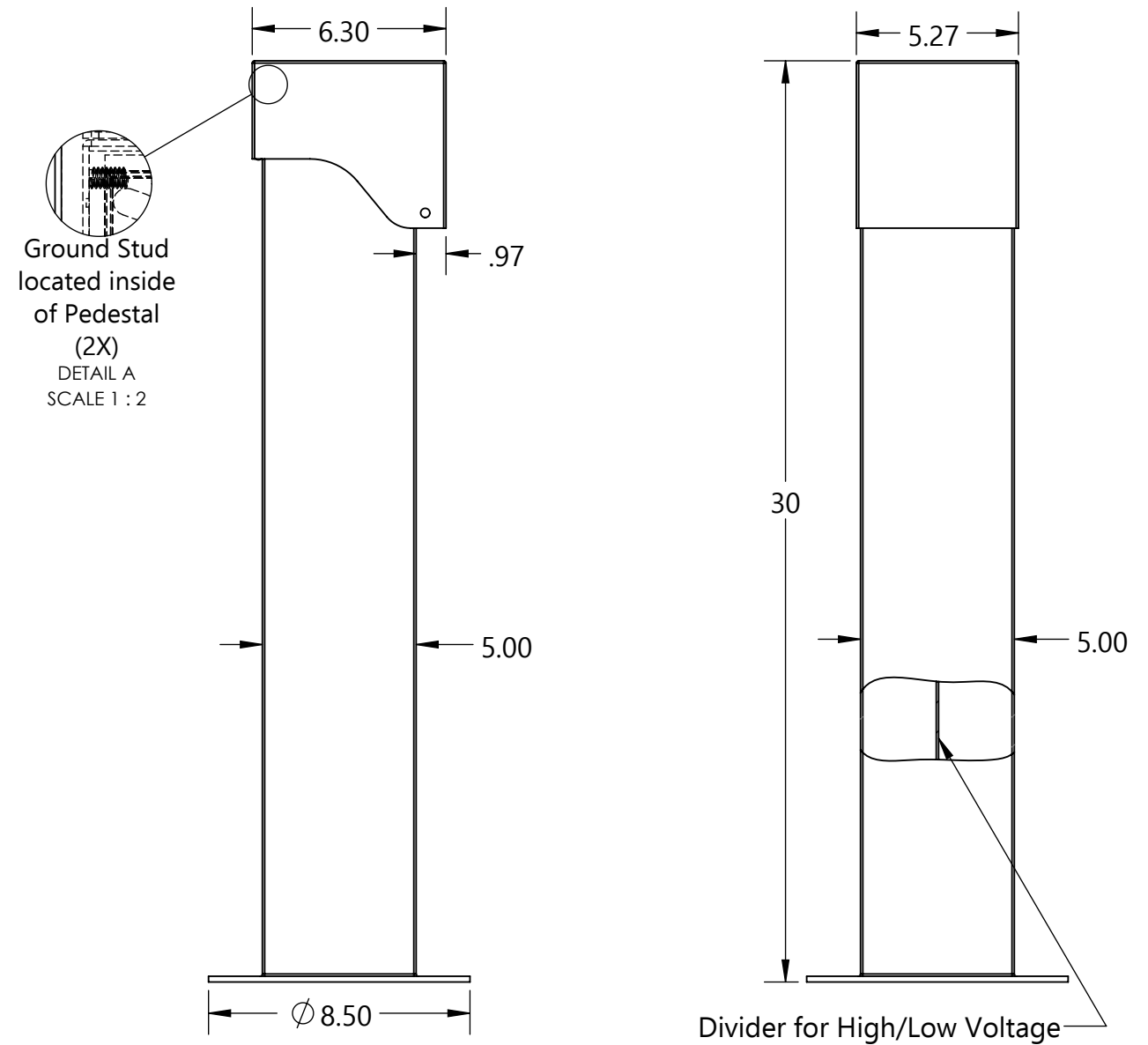
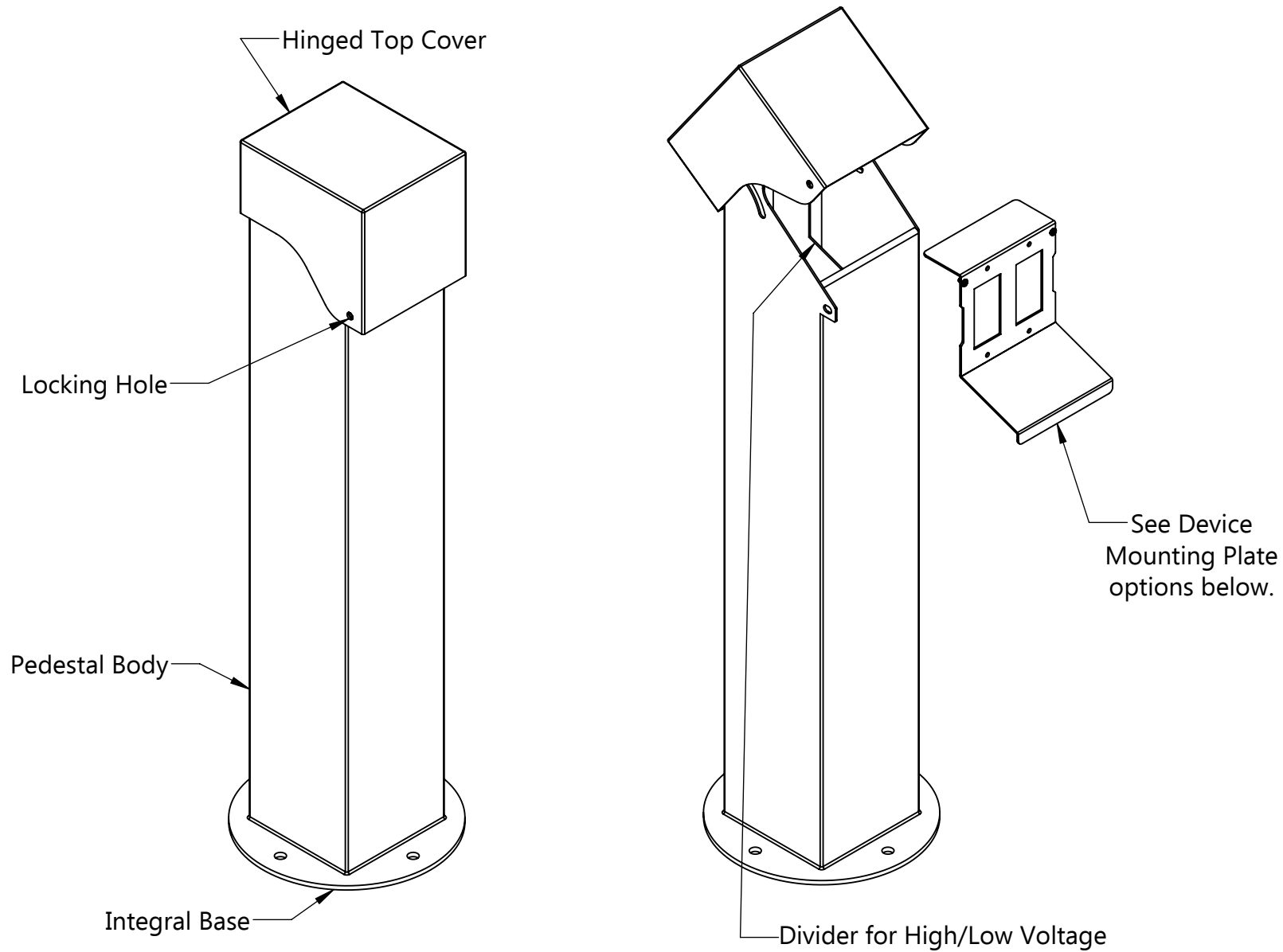

Material

14 Ga. 304 Stainless Steel: Pedestal Body, Cover, Device Mounting Plate
 7 Ga. 304 Stainless Steel: Integral Base

Base Mounting Hardware (included)

- (4) 1/4"-20 x 2-1/4" S.S. Wedge Anchors
- (4) 1/4"-20 S.S. High Crown Acorn Cap Nut
- (4) 1/4" x Ø 5/8" x .045" Thick S.S. Flat Washer

Packaging

Boxed Dimensions: 11" x 11" x 45"
 Boxed Weight: 26 Lbs.

Complete Part Numbers with Finish		Device Mtg. Plate Configurations	
Powder Coated ("C")	Brushed Finish ("SS")	Description	
5P30-C-D-HT-*-140	5P30-SS-D-HT-140	PED0140 (2-Gang)	
5P30-C-D-HT-*-144	5P30-SS-D-HT-144	PED0144 (30A 1-9/16" & 20A)	

* Color Code: B = Black, G = Gray, GN = Green, BR = Brown, BRZ = Bronze, CSTM = Custom Color

