

Model Type: Hinge Top with Integral Base
Description: 30" Hinge Top with Integral Base

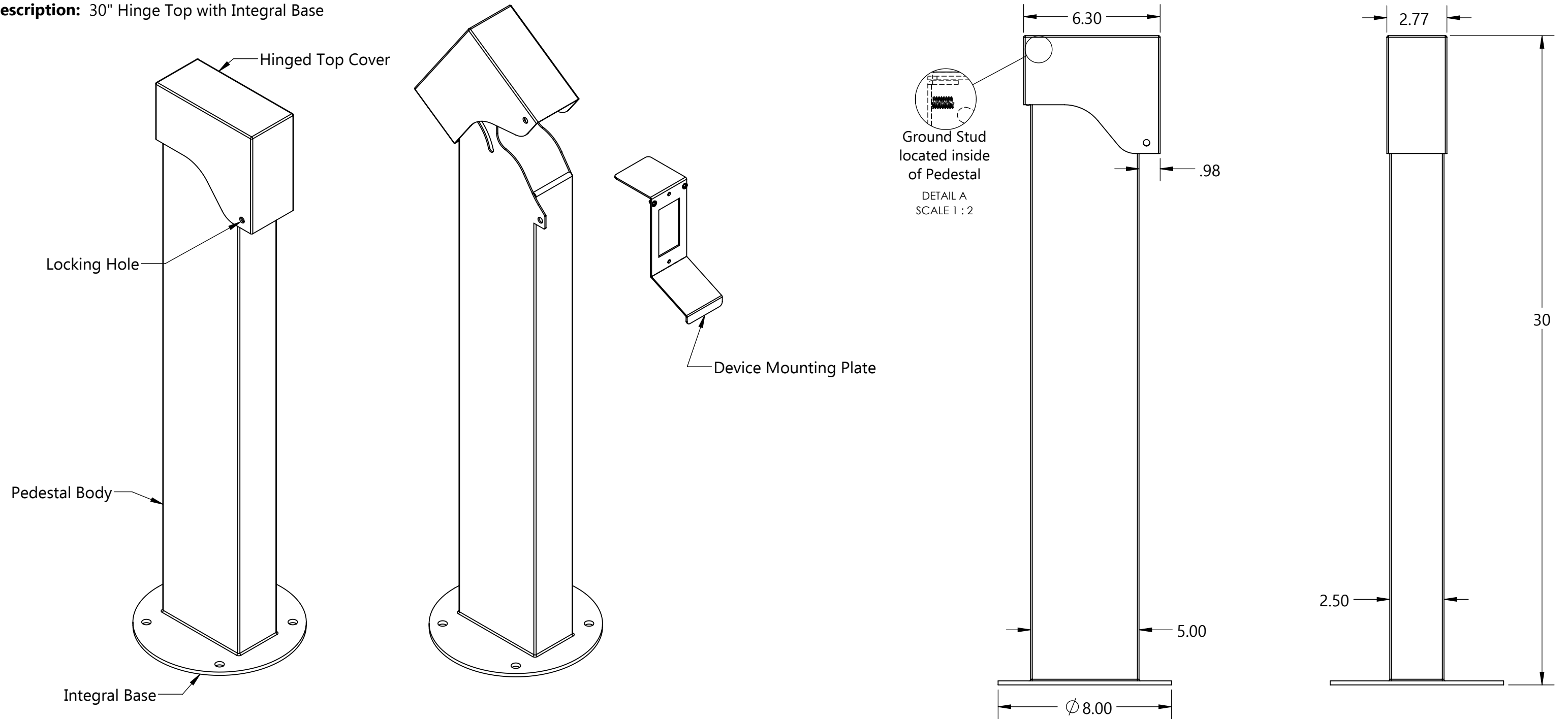

Part Numbers with Finish Indicated		Material	
Powder coated stainless steel			
Black (B)	1P30-C-HT-B	Pedestal Body	14 gauge stainless steel
Gray (G)	1P30-C-HT-G	Hinged Cover	14 gauge stainless steel
Bronze (BRZ)	1P30-C-HT-BRZ	Device Mounting Plate	14 gauge stainless steel
Green (GN)	1P30-C-HT-GN	Integral Base	7 gauge stainless steel
Brown (BR)	1P30-C-HT-BR		
Custom (CSTM)	1P30-C-HT-CSTM (paint chip req'd)	Packaged Dimensions	11" x 11" x 45"
Brushed stainless steel	1P30-SS-HT	Packaged Weight	17 Lbs.

Base Mounting Hardware (included)
 (4) 1/4"-20 x 2-1/4" S.S. Wedge Anchors
 (4) 1/4"-20 S.S. High Crown Acorn Cap Nut
 (4) 1/4" x Ø 5/8" x .045" Thick S.S. Flat Washer

