

Model Type: Divided - 5x5 Hinge Top Without Base: Direct Bury
Description: Divided 54" 5x5 Hinge Top Without Base: Direct Bury

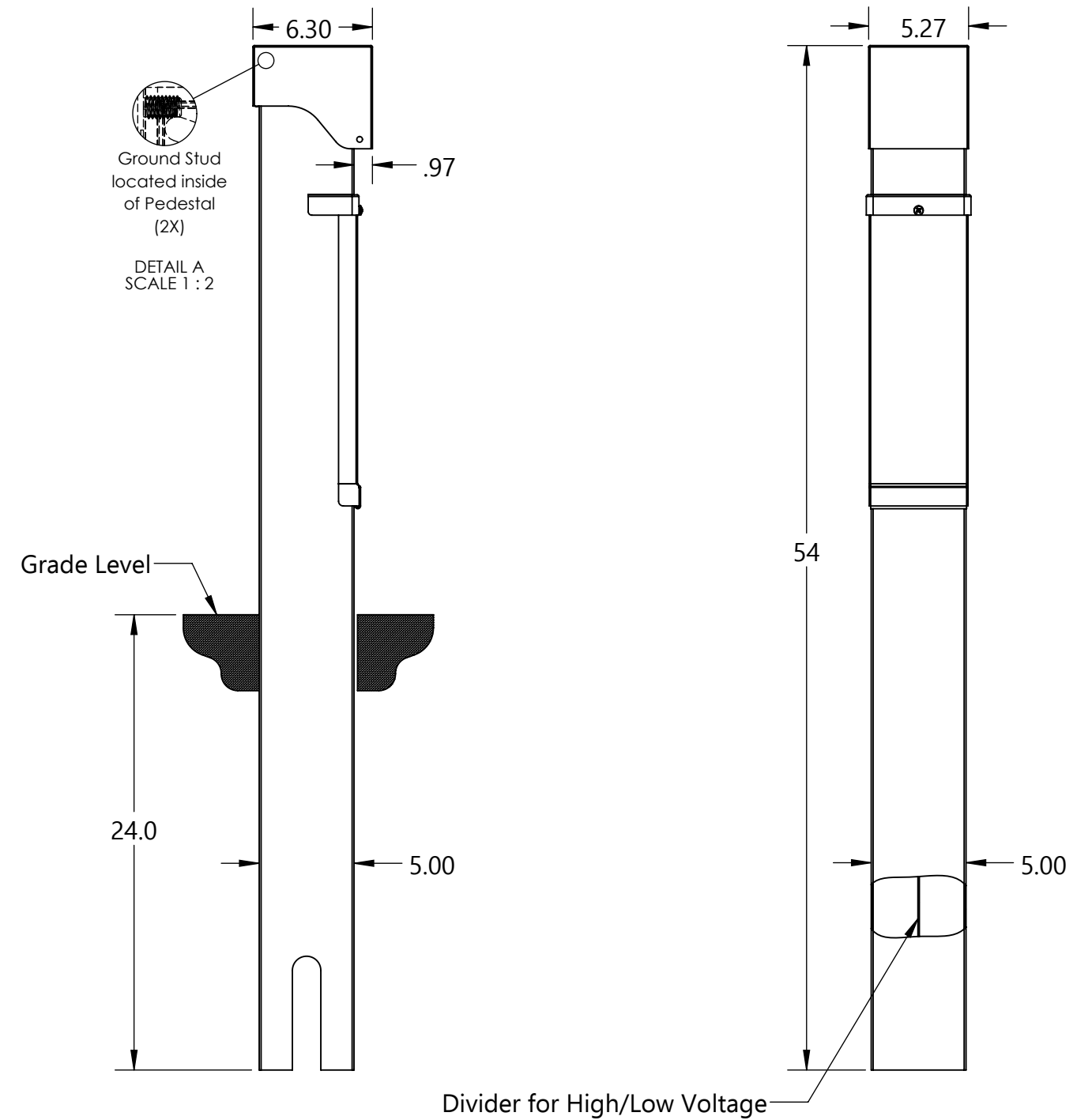
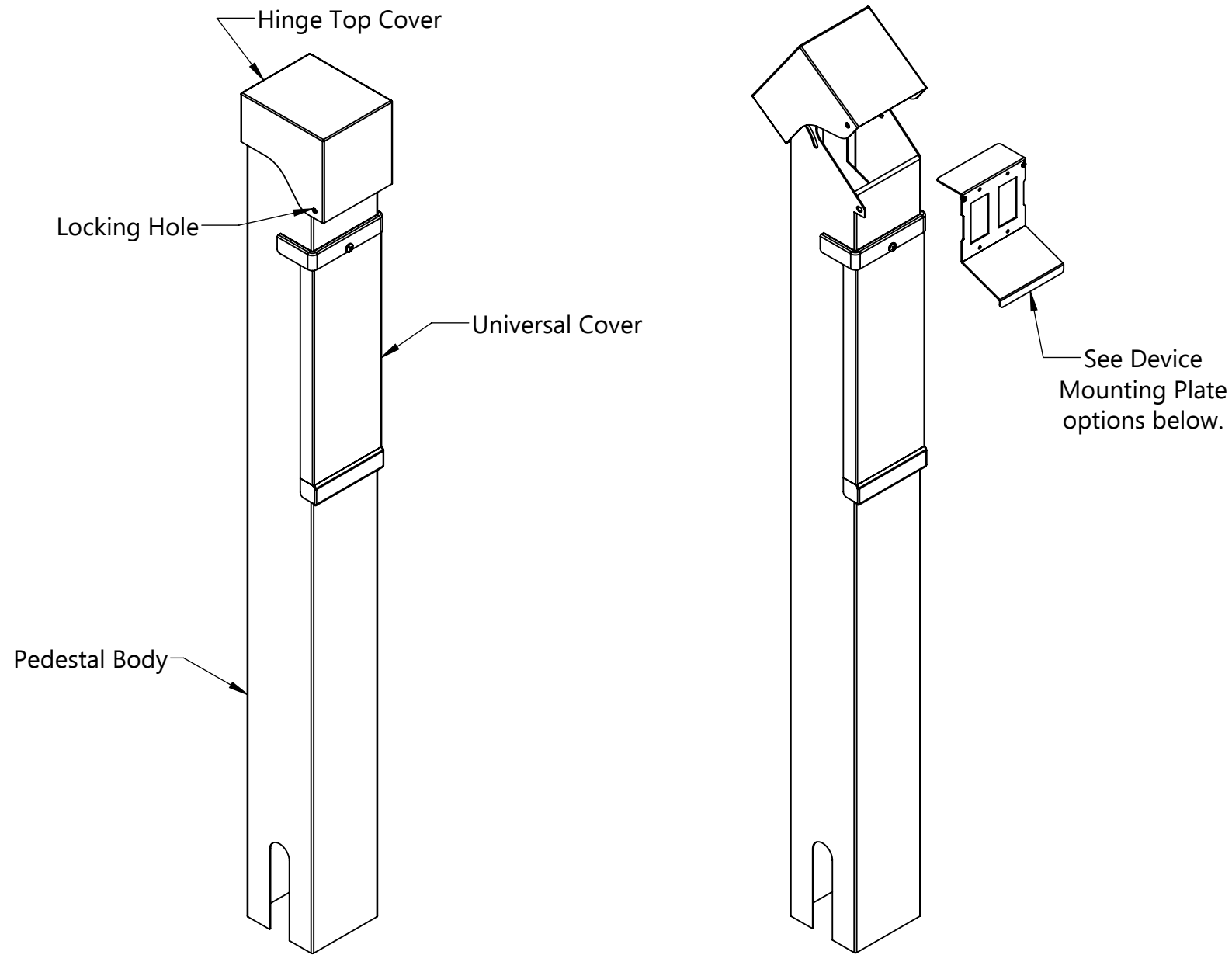

Material

14 Ga. 304 Stainless Steel: Pedestal Body, Top Cover, Universal Cover, Device Mounting Plate

Packaging

Boxed Dimensions: 9" x 9" x 56"
 Boxed Weight: 35 Lbs.

Complete Part Numbers with Finish		Device Mtg. Plate Configurations	
Powder Coated ("C")	Brushed Finish ("SS")	Description	
554-C-D-HT-*-140	554-SS-D-HT-140	PED0140 (2-Gang)	
554-C-D-HT-*-144	554-SS-D-HT-144	PED0144 (30A 1-9/16" & 20A)	

* Color Code: B = Black, G = Gray, GN = Green, BR = Brown, BRZ = Bronze, CSTM = Custom Color

