

# Specifications: 5x5 hinge Top with Integral Base

Wider body for dual charging



UL Listed: Standard 1773. Rated NEMA 3R. Options that meet ADA minimum 15" receptacle height requirement.

## 5x5 Hinge Top with Integral Base | 1-, 2-, 3-gang (up to 30 amp devices)

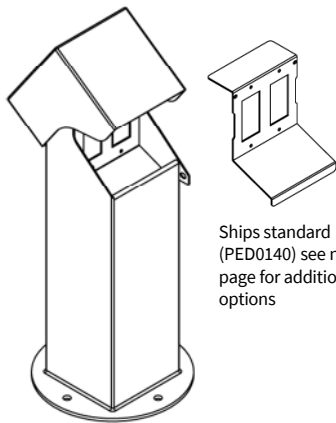

Ships standard (PED0140) see next page for additional options

Free standing power pedestals that are an aesthetically pleasing solution to safely and conveniently bring power to any outdoor location. Offering hundreds of configurations and finishes, Pedocs will blend into any landscape.

Material	304 Stainless Steel: 14-gauge body, 7-gauge base; optional upgrade to 316
Construction	Welded pedestal body, base and welded weatherproof cover (lockable)
Finishes	Outdoor rated powder coat paint (standard and custom), brushed stainless
Heights	18", 24", 30", 36", 42", 48"
Dimensions	5" wide by 5" deep pedestal; 5-1/4" wide by 6-1/4" deep cover, 8-1/2" dia. base
Amperage	Accepts up to 30 amp devices
Hardware	Pre-installed SS grounding hardware; anchoring hardware included
Application	May be ordered with a divider for high and low voltage (data)
Customization	Custom powder coat options
Installation	Open base to accommodate two 1-1/2" conduit raceways
Device Mount	Removable GFCI device mounting plate insert included
Additional	Devices not supplied

## Product Highlights



Devices not supplied

Featuring a welded stainless steel lockable tamperproof cover

- Self-closing cover prevents ingress of water from outdoor elements
- Spacing between cover and pedestal to allow cords to safely pass
- Locking tab to prevent unwanted use
- Heavy stainless steel (SS) welded construction
- Choice of device mounting plates
- May be ordered with an internal dividing channel to separate high and low voltage
- Heavy stainless steel (SS) welded construction



## Part Numbering Guide

### Example of photo above:

5P18-C-HT-1-G

- 5 (always for this model)
- P (always for this model)
- 18 (18" tall)
- C (coated finish)
- left blank for non-divided
- HT (always for this model)
- 1 (20A; PED0140 ships standard)
- G (gray)

Mtg. type	Hgt.	Finish type	High/low volt. divider	Cover	Max. amp.	Color (coated only)
5P (always)	18"	-C: powder coated -SS: brushed	Leave blank for non-divided -D: divided	-HT (always)	-1: 20 amp -2: corner divided models -3: 30-amp	-B: black
	24"					-G: gray
	30"					-BRZ: bronze
	36"					-GN: green
	42"					-BR: brown
48"	-*CSTM: custom Leave blank for brushed finish					

### Finishes

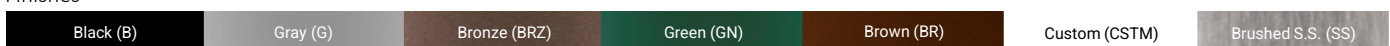

# 5x5 Device Mounting Plates

UL Listed: Standard 1773. Rated NEMA 3R. Options that meet ADA minimum 15" receptacle height requirement.

## Device Mounting Configurations for 5x5 With and Without Base Models

Each 5x5 models comes with one removeable device mounting plate. When specifying or ordering, indicate the corresponding preferred PED number.

### Suitable for 20 Amp models (HT-1)

PED0140  
Standard 2-gang

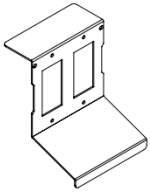

PED0197  
3-gang

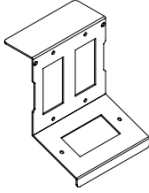

PED0142  
30A 1-9/16"

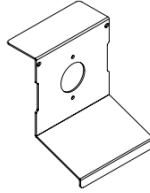

PED0148  
30A 2-1/8"

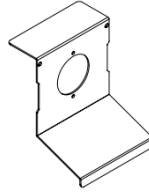

PED0138  
Dual 30A 1-9/16"

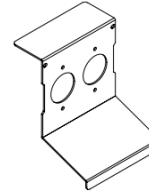

PED0144  
Duplex, 30A 1-9/16"

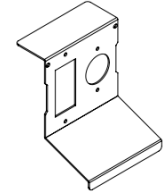

### Suitable for 30 Amp models (HT-3)

### Suitable for Corner Divided Models (D-HT-2)

PED0141  
2 duplex, 2 data

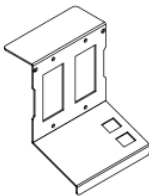

PED0147  
2 duplex, 4 data

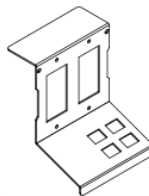

PED0139  
Dual 30A, 2 data

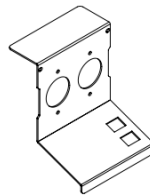

PED0143  
30A 1-9/16, 2 data

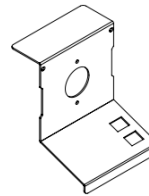

PED0145  
Duplex, 30A, 2 data

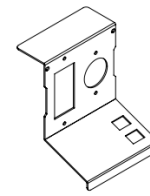

PED0146  
30A 2-1/8", 2 data

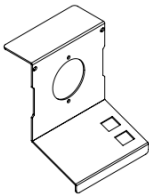

PED0149  
30A 1-9/16", 4 data

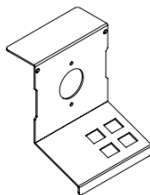

PED0151  
Duplex, 30A, 4 data

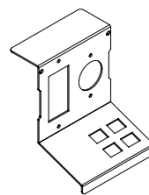

PED0150  
30A 2-1/8", 4 data

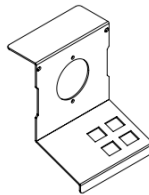

PED0152  
Dual 30A 1-9/16", 4 data

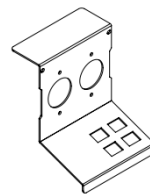

### Suitable for Center Divided Models (D-HT-1, -3)

PED0140  
Standard 2-gang

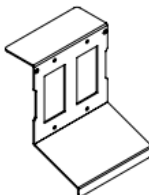

PED0144  
Duplex, 30A 1-9/16"

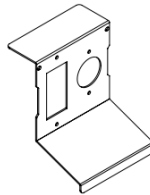

Typical  
Dimensions

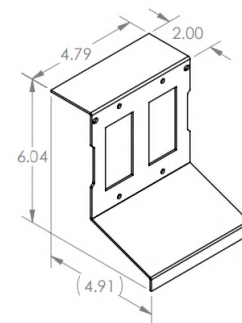

### Finishes

Black (B)

Gray (G)

Bronze (BRZ)

Green (GN)

Brown (BR)

Custom (CSTM)

Brushed S.S. (SS)